

5 APPENDIX

5.1 MAINTENANCE

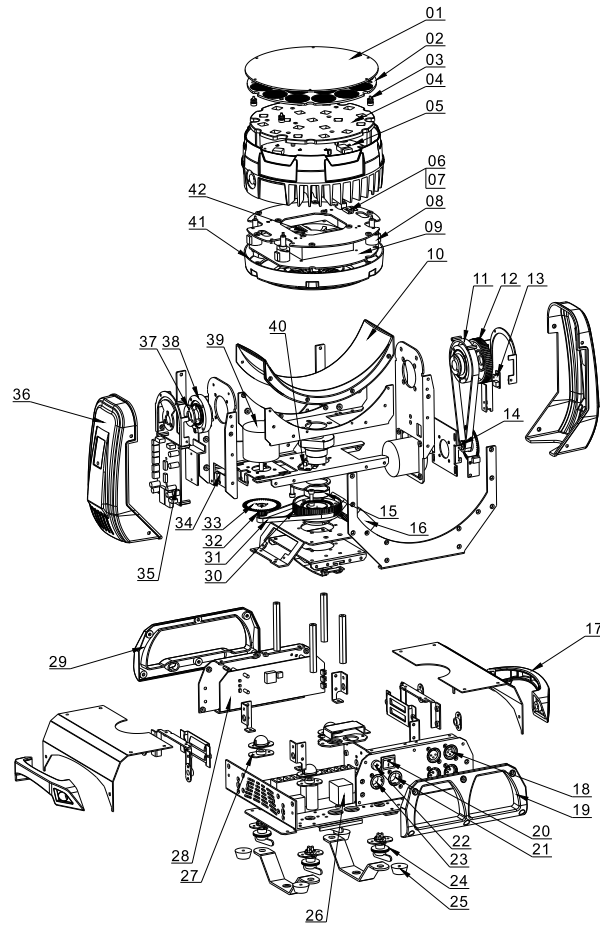

NO	Part name	NO	Part name	NO	Part name	NO	Part name
1	Head dustproof lens	11	Synchronous belt(Y axis)	21	PS socket (male)	31	Synchronous belt(X axis)
2	Focus lens(19 in I)	12	Y-large gear	22	Fuse holder	32	Y-small gear
3	Adjust pole	13	Magnetic stopper sensor(Y axis)	23	PS socket (male)	33	Optical wheel
4	Reflective bowl(19 in I)	14	Y axis small gear	24	Quick-lock	34	Optical stopper sensor
5	LED board	15	X axis baffle gasket	25	LT6 Engineering feet	35	Motor Driver board
6	Thermal switch holder	16	SUNON Fan(Base)	26	Power Supply	36	631 Plastic arm
7	Thermal switch	17	LED623 Handgrip	27	Quick-lock cushion	37	Y axis baffle gasket 1
8	Linear motor	18	Adaptor PCB	28	Display board	38	Y bearings combination
9	LED Driver board	19	Base box plastic cover(PS)	29	Base box plastic cover(Display)	39	Three-phase stepper motor
10	631 Plastic arm cover	20	Power switch	30	X bearings gear combination	40	Magnetic stopper sensor(X axis)
						41	631 Head plastic back cover
						42	Fan(Head)

CYAN 6000XE

USER MANUAL

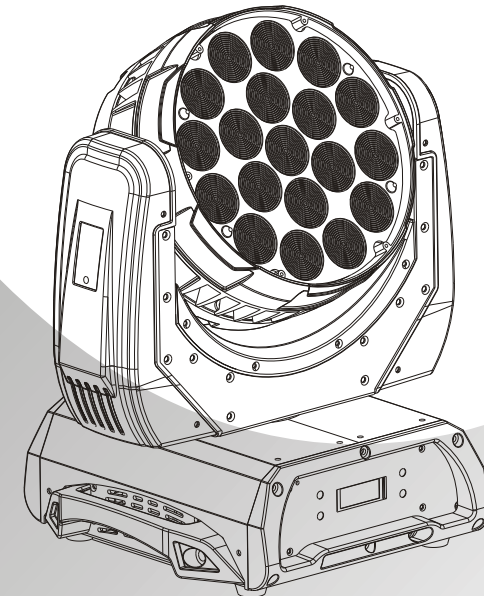

SS631

SILVER STAR
Professional Lighting

www.yajiang.cn

RD-SS631-SM-00(SS-I)

1 PRODUCT SPECIFICATIONS

1.1 PRODUCT SPECIFICATIONS

Electrical

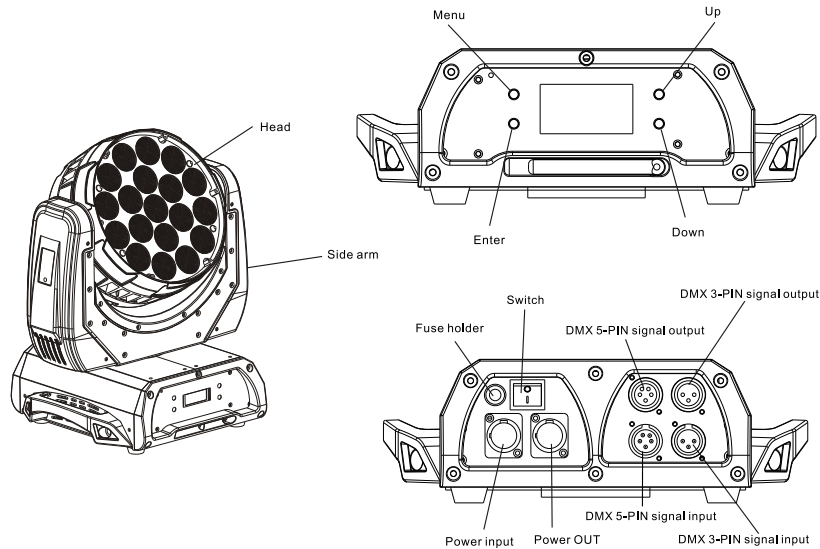

- ◆ Voltage: AC100~240V, 50/60Hz
- ◆ Max Power: 350W
- ◆ Size: 338x270x341mm
- ◆ Weight: 10kg

1.2 PRODUCT FEATURES



CHANNEL	FUNCTION	VALUE	EFFECT
11	RED1	000 ↔ 255	RED1
12	RED1 FINE	000 ↔ 255	RED1 FINE
13	GREEN1	000 ↔ 255	GREEN1
14	GREEN1 FINE	000 ↔ 255	GREEN1 FINE
15	BLUE1	000 ↔ 255	BLUE1
16	BLUE1 FINE	000 ↔ 255	BLUE1 FINE
17	WHITE1	000 ↔ 255	WHITE1
18	WHITE1 FINE	000 ↔ 255	WHITE1 FINE
19	RED2U	000 ↔ 255	RED2U
20	RED2UFINE	000 ↔ 255	RED2UFINE
21	GREEN2U	000 ↔ 255	GREEN2U
22	GREEN2U FINE	000 ↔ 255	GREEN2U FINE
23	BLUE2U	000 ↔ 255	BLUE2U
24	BLUE2U FINE	000 ↔ 255	BLUE2U FINE
25	WHITE2U	000 ↔ 255	WHITE2U
26	WHITE2U FINE	000 ↔ 255	WHITE2U FINE
27	RED2D	000 ↔ 255	RED2D
28	RED2D FINE	000 ↔ 255	RED2D FINE
29	GREEN2D	000 ↔ 255	GREEN2D
30	GREEN2D FINE	000 ↔ 255	GREEN2D FINE
31	BLUE2D	000 ↔ 255	BLUE2D
32	BLUE2D FINE	000 ↔ 255	BLUE2D FINE
33	WHITE2D	000 ↔ 255	WHITE2D
34	WHITE2D FINE	000 ↔ 255	WHITE2D FINE

PERSON5

CHANNEL	FUNCTION	VALUE	EFFECT
1	PAN	000 ↔ 255	0~540°
2	PAN FINE	000 ↔ 255	0~3°
3	TILT	000 ↔ 255	0~270°
4	TILT FINE	000 ↔ 255	0~3°
5	PAN/TILT SPEED	000 ↔ 255	From fast to slow
6	DIMMER	000 ↔ 255	Dark to light 
7	DIMMER FINE	000 ↔ 255	Dark to light 
8	STROBE	000 ↔ 009 010 ↔ 255	NO function 1~20Hz
9	ZOOM	000 ↔ 255	Since the zoom 
10	CONTROL	000 ↔ 019 020 ↔ 039 040 ↔ 059 060 ↔ 079 080 ↔ 099 100 ↔ 119 120 ↔ 139 140 ↔ 149 150 ↔ 159 160 ↔ 169 170 ↔ 179 180 ↔ 199 200 ↔ 219 220 ↔ 235 236 ↔ 239 240 ↔ 243 244 ↔ 247 248 ↔ 251 252 ↔ 255	NO FUNCTION PAN/TILT BLACK ACTIVATED PAN/TILT BLACK DEACTIVATED FAN AUTO FAN SLOW FAN NORMAL FAN FAST AUTO1 AUTO2 TEST CUSTOM NO FUNCTION RESET NO FUNCTION DIM0 DIM1 DIM2 DIM3 DIM4

1.3 SAFETY WARNING

IMPORTANT:

- This product must be installed by a qualified professional.
- All maintenance must be carried out by a qualified electrician.
- A minimum distance of 0.5m must be maintained between the equipment and a combustible surface.
- The product must always be operated in a well ventilated area.
- DO NOT stare directly into the LED light source.
- Always disconnect the power before carrying out any maintenance.
- The earth must always be connected to the ground.
- Ensure that all parts of the equipment are kept clean and free of dust.

2 INSTALLATION

2.1 MOUNTING:

- The fixture can be mounted in any position.
- Always ensure that mounting surface can withstand 10 times the weight of the fixture.
- Always use a safety cable when mounting the fixture in any elevated position.

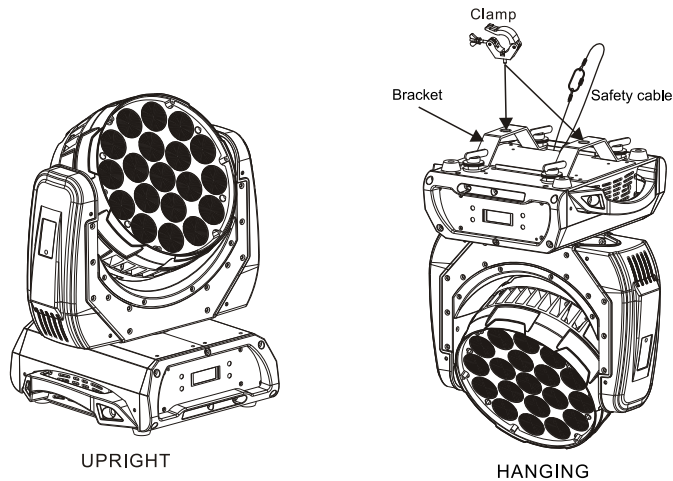

IMPORTANT SAFETY NOTE!!

Always use a safety cable when installing this unit!!
Be sure that the safety cable is connected to a solid load-bearing structure.



2.2 POWER CONNECTIONS

- 220~240V: 8 units may be connected in series
- 110~120V: 4 units may be connected in series

Note:

If the signal cable is over 60m between the DMX512 controller and fixture or between two fixtures, then a DMX signal amplifier is needed as well.

PERSON4

CHANNEL	FUNCTION	VALUE	EFFECT
1	PAN	000 ↔ 255	0~540°
2	PAN FINE	000 ↔ 255	0~3°
3	TILT	000 ↔ 255	0~270°
4	TILT FINE	000 ↔ 255	0~3°
5	PAN/TILT SPEED	000 ↔ 255	From fast to slow
6	DIMMER	000 ↔ 255	Dark to light 
7	STROBE	000 ↔ 009 010 ↔ 255	NO function 1~20Hz
8	ZOOM	000 ↔ 255	Since the zoom 
9	CONTROL	000 ↔ 019 020 ↔ 039 040 ↔ 059 060 ↔ 079 080 ↔ 099 100 ↔ 119 120 ↔ 139 140 ↔ 149 150 ↔ 159 160 ↔ 169 170 ↔ 179 180 ↔ 199 200 ↔ 219 220 ↔ 235 236 ↔ 239 240 ↔ 243 244 ↔ 247 248 ↔ 251 252 ↔ 255	NO FUNCTION PAN/TILT BLACK ACTIVATED PAN/TILT BLACK DEACTIVATED FAN AUTO FAN SLOW FAN NORMAL FAN FAST AUTO1 AUTO2 TEST CUSTOM NO FUNCTION RESET NO FUNCTION DIM0 DIM1 DIM2 DIM3 DIM4
10	RED1	000 ↔ 255	RED1
11	GREEN1	000 ↔ 255	GREEN1
12	BLUE1	000 ↔ 255	BLUE1
13	WHITE1	000 ↔ 255	WHITE1
14	RED2U	000 ↔ 255	RED2U
15	GREEN2U	000 ↔ 255	GREEN2U
16	BLUE2U	000 ↔ 255	BLUE2U
17	WHITE2U	000 ↔ 255	WHITE2U
18	RED2D	000 ↔ 255	RED2D
19	GREEN2D	000 ↔ 255	GREEN2D
20	BLUE2D	000 ↔ 255	BLUE2D
21	WHITE2D	000 ↔ 255	WHITE2D

PERSON3

CHANNEL	FUNCTION	VALUE	EFFECT
1	PAN	000 ↔ 255	Clockwise rotate 0~540°
2	TILT FINE	000 ↔ 255	Fine control of tilt movement 0~270°
3	HUE	000 ↔ 255	HUE
4	SATURATION	000 ↔ 255	SATURATION
5	VALUE	000 ↔ 255	VALUE
6	STROBE	000 ↔ 009 010 ↔ 255	NO function 1~20Hz
7	ZOOM	000 ↔ 255	Since the zoom 
8	CONTROL	000 ↔ 019 020 ↔ 039 040 ↔ 059 060 ↔ 079 080 ↔ 099 100 ↔ 119 120 ↔ 139 140 ↔ 149 150 ↔ 159 160 ↔ 169 170 ↔ 179 180 ↔ 199 200 ↔ 219 220 ↔ 235 236 ↔ 239 240 ↔ 243 244 ↔ 247 248 ↔ 251 252 ↔ 255	NO FUNCTION PAN/TILT BLACK ACTIVATED PAN/TILT BLACK DEACTIVATED FAN AUTO FAN SLOW FAN NORMAL FAN FAST AUTO1 AUTO2 TEST CUSTOM NO FUNCTION RESET NO FUNCTION DIM0 DIM1 DIM2 DIM3 DIM4

2.3 FUSE REPLACEMENT

- Remove the safety cap by a screwdriver.
- Fetch the old fuse from safety cap.
- Install a new fuse.
- Install the safety cap.

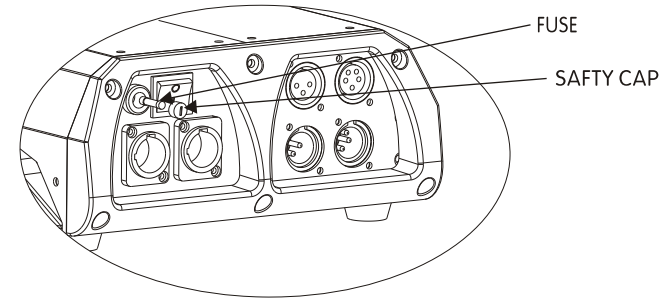

3 DISPLAY PANEL OPERATION

3.1 DISPLAY OPERATION

- ◆ MENU: BACK;
- ◆ ENTER: ENTER OR SAVE;
- ◆ DOWN: DOWN;
- ◆ UP: UP;

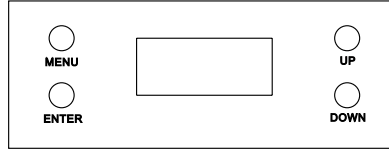

3.2 MENU MAP

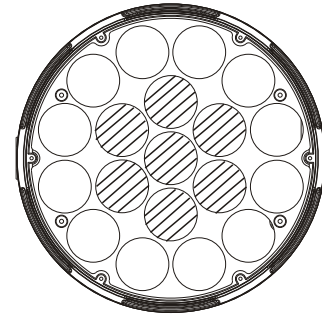
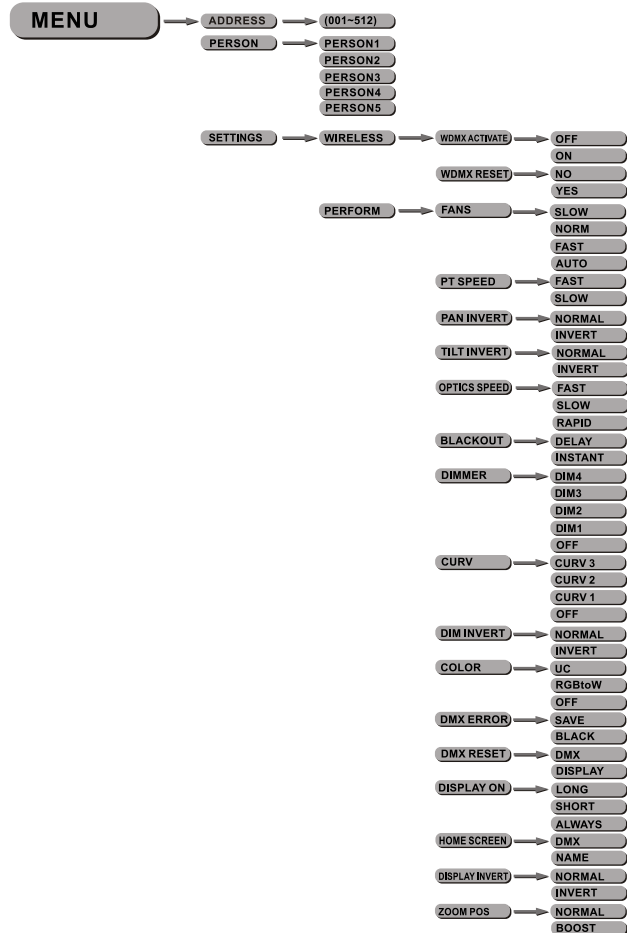

RING 1

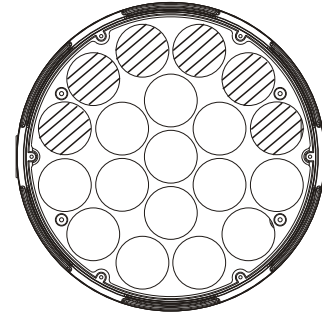

RING 2D

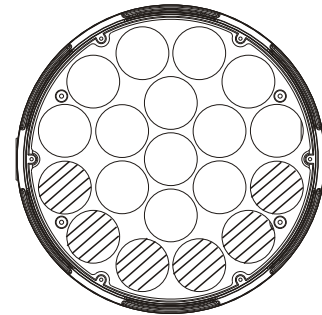

RING 2U

To identify up, middle and down by head which after the fixture electrify & reset

CHANNEL	FUNCTION	VALUE	EFFECT
15	AUTO RINGS	000 ⇔ 009	ALL RINGS
		010 ⇔ 019	STATIC RING 1
		020 ⇔ 029	STATIC RING 2u
		030 ⇔ 039	STATIC RING 2d
		040 ⇔ 049	RING EFFECT 1: FILL centre-out with black (1, 1+2u+2d,0)
		050 ⇔ 059	RING EFFECT 2: FILL out-centre with black (2u+2d+1, 1, 0)
		060 ⇔ 069	RING EFFECT 3: RING centre-out with black (1, 2u+2d, 0)
		070 ⇔ 079	RING EFFECT 4: RING out-centre with black (2u+2d, 1, 0)
		080 ⇔ 089	RING EFFECT 5: DOT-FILL centre-out with black (1,0,1+2U+2d,0)
		090 ⇔ 099	RING EFFECT 6: DOT-FILL out-centre with black (1+2u+2d,0,1,0)
		100 ⇔ 109	RING EFFECT 7: DOT STROBE (1, 0)
		110 ⇔ 119	RING EFFECT 8: RING STROBE (2u+2d, 0)
		120 ⇔ 129	RING EFFECT 9: LINES ONEWAY (2u, 1, 2d)
		130 ⇔ 139	RING EFFECT 10: LINES ONEWAY with black (2u, 1, 2d, 0)
		140 ⇔ 149	RING EFFECT 11: LINES TWOWAY (2u, 1, 2d, 1, 2u)
		150 ⇔ 159	RING EFFECT 12: LINES TWOWAY with black (2u, 1, 2d, 2d, 1, 2u,0)
		160 ⇔ 169	RING EFFECT 13: OPPOSITE LINE (2u,2d)
		170 ⇔ 179	RING EFFECT 14: OPPOSITE ring with black (2u,2d,0)
		180 ⇔ 189	STATIC RING WITH COLOR 1: (1=green, 2u+2d=red)
		190 ⇔ 199	STATIC RING WITH COLOR 2: (1=blue, 2u+2d=red)
		200 ⇔ 209	STATIC RING WITH COLOR 3: (1=white, 2u+2d=red)
		210 ⇔ 219	STATIC RING WITH COLOR 4: (1=red, 2u+2d=blue)
		220 ⇔ 229	STATIC RING WITH COLOR 5: (1=green, 2u+2d=blue)
		230 ⇔ 239	STATIC RING WITH COLOR 6: (1=white, 2u+2d=blue)
		240 ⇔ 249	STATIC RING WITH COLOR 6: (2u+2d=green,1=red)
250 ⇔ 255	ALL RINGS		
16	AUTO SPEED	000 ⇔ 255	Slow to fast
17	DIMMER	000 ⇔ 255	Dark to light
18	DIMMER FINE	000 ⇔ 255	Dark to light
19	STROBE	000 ⇔ 009 010 ⇔ 255	NO function 1~20Hz
20	ZOOM	000 ⇔ 255	Since the zoom
21	CONTROL	000 ⇔ 019	NO FUNCTION
		020 ⇔ 039	PAN/TILT BLACK ACTIVATED
		040 ⇔ 059	PAN/TILT BLACK DEACTIVATED
		060 ⇔ 079	FAN AUTO
		080 ⇔ 099	FAN SLOW
		100 ⇔ 119	FAN NORMAL
		120 ⇔ 139	FAN FAST
		140 ⇔ 149	AUTO1
		150 ⇔ 159	AUTO2
		160 ⇔ 169	TEST
		170 ⇔ 179	CUSTOM
		180 ⇔ 199	NO FUNCTION
		200 ⇔ 219	RESET
		220 ⇔ 235	NO FUNCTION
		236 ⇔ 239	DIM0
		240 ⇔ 243	DIM1
		244 ⇔ 247	DIM2
		248 ⇔ 251	DIM3
		252 ⇔ 255	DIM4

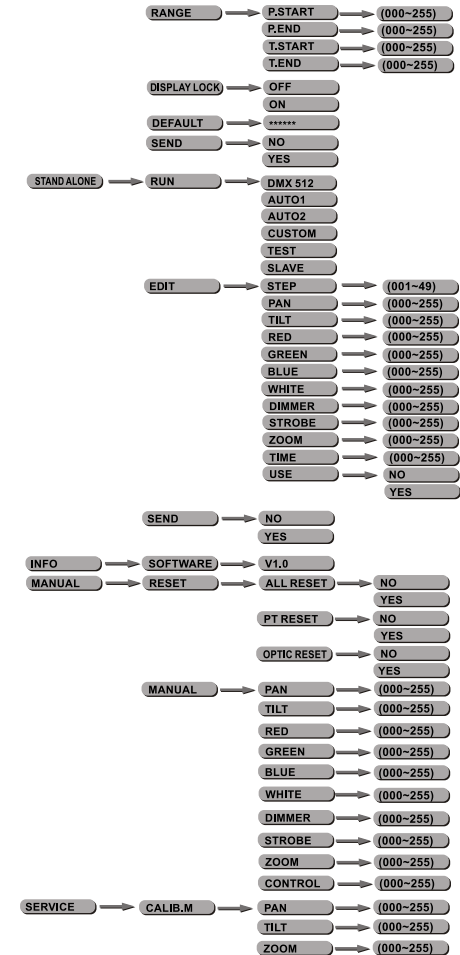

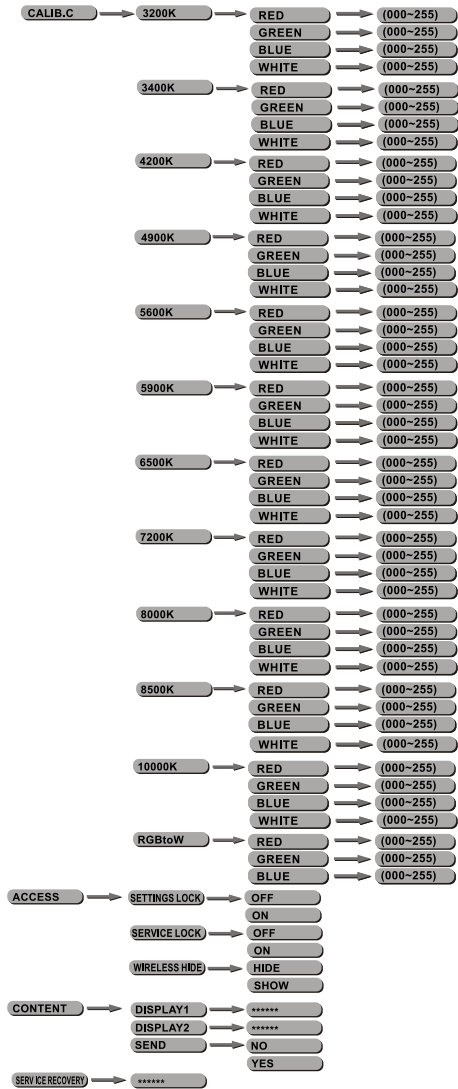

PERSON2



CHANNEL	FUNCTION	VALUE	EFFECT
1	PAN	000 ↔ 255	0~540°
2	PAN FINE	000 ↔ 255	0~3°
3	TILT	000 ↔ 255	0~270°
4	TILT FINE	000 ↔ 255	0~3°
5	PAN/TILT SPEED	000 ↔ 255	From fast to slow
6	RED	000 ↔ 255	RED
7	RED FINE	000 ↔ 255	RED FINE
8	GREEN	000 ↔ 255	GREEN
9	GREEN FINE	000 ↔ 255	GREEN FINE
10	BLUE	000 ↔ 255	BLUE
11	BLUE FINE	000 ↔ 255	BLUE FINE
12	WHITE	000 ↔ 255	WHITE
13	WHITE FINE	000 ↔ 255	WHITE FINE
14	COLOR/ WHITE MACRO	000 ↔ 005 006 ↔ 010 011 ↔ 030 031 ↔ 050 051 ↔ 070 071 ↔ 090 091 ↔ 110 111 ↔ 130 131 ↔ 150 151 ↔ 170 171 ↔ 200 201 ↔ 205 206 ↔ 210 211 ↔ 215 216 ↔ 220 221 ↔ 225 226 ↔ 230 231 ↔ 235 236 ↔ 240 241 ↔ 245 246 ↔ 250 251 ↔ 255	NO FUCNTION NO FUCNTION RED 100% / GREEN UP / BLUE 0% RED DOWN / GREEN 100% / BLUE 0% RED 0% / GREEN 100% / BLUE UP RED 0% / GREEN DOWN / BLUE 100% RED UP / GREEN 0% / BLUE 100% RED 100% / GREEN 0% / BLUE DOWN RED 100% / GREEN UP / BLUE UP RED DOWN / GREEN DOWN / BLUE 100% RED 100% / GREEN 100% / BLUE 100% / WHITE 100% WHITE1: 3200K WHITE2: 3400K WHITE3: 4200K WHITE4: 4900K WHITE5: 5600K WHITE6: 5900K WHITE7: 6500K WHITE8: 7200K WHITE9: 8000K WHITE10: 8500K WHITE11: 10000K

4 USING A DMX512 CONTROLLER

4.1 CHANNEL ASSIGNMENT

- Note: This product have five DMX512 channel configuration: **【PERSON1】 / 【PERSON2】 / 【PERSON3】 【PERSON4】** and **【PERSON5】** .

PERSON1

CHANNEL	FUNCTION	VALUE	EFFECT
1	PAN	000 ↔ 255	Clockwise rotate 0~540°
2	TILT	000 ↔ 255	Fine control of tilt movement 0~270°
3	RED	000 ↔ 255	RED
4	GREEN	000 ↔ 255	GREEN
5	BLUE	000 ↔ 255	BLUE
6	WHITE	000 ↔ 255	WHITE
7	DIMMER	000 ↔ 255	Dark to light 
8	STROBE	000 ↔ 009 010 ↔ 255	NO function 1~20Hz
9	ZOOM	000 ↔ 255	Since the zoom 
10	CONTROL	000 ↔ 019 020 ↔ 039 040 ↔ 059 060 ↔ 079 080 ↔ 099 100 ↔ 119 120 ↔ 139 140 ↔ 149 150 ↔ 159 160 ↔ 169 170 ↔ 179 180 ↔ 199 200 ↔ 219 220 ↔ 235 236 ↔ 239 240 ↔ 243 244 ↔ 247 248 ↔ 251 252 ↔ 255	NO FUNCTION PAN/TILT BLACK ACTIVATED PAN/TILT BLACK DEACTIVATED FAN AUTO FAN SLOW FAN NORMAL FAN FAST AUTO1 AUTO2 TEST CUSTOM NO FUNCTION RESET NO FUNCTION DIM0 DIM1 DIM2 DIM3 DIM4

3.3 DMX512 SETTINGS

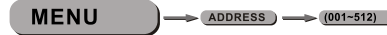

- Enter the **【DMX】** mode to set the DMX ADDRESS.

3.4 PERSONALITY

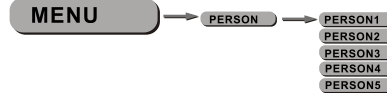

- Enter the **【PERSONALITY】** mode to select DMX mode: **【PERSON1】** , **【PERSON2】** , **【PERSON3】** , **【PERSON4】** , **【PERSON5】** .

3.5.1 DATA

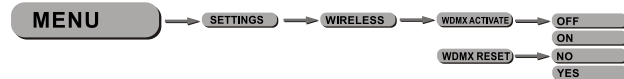

- Select **【DATA】** from the **【SETTINGS】** menu.
- 【WDMX ACTIVATE】** menu, select **【ON/OFF】** for WDMX activation
- 【WDMX RESET】** menu, select **【NO/YES】** for resetting the WDMX function.
Please note that a fixture must be reset before it can be paired with a new WDMX transmitter.

3.52 PERFORM

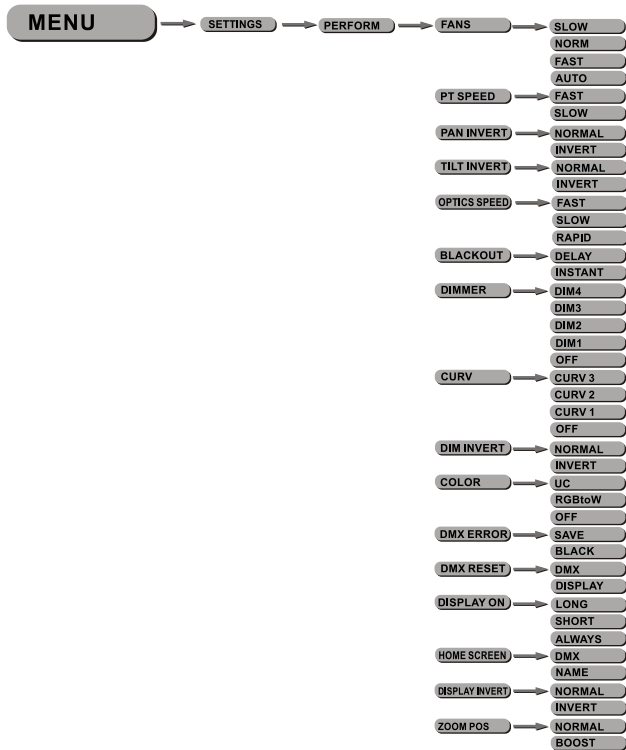

- Select **PERFORM** from the **SETTINGS** menu.
- **FANS** menu, select **Slow/Norm/Fast/Auto** as required fan speed.
- **PT SPEED** menu, select **Slow/Fast** as required PAN/TILT movement speed.
- **PAN INVERT** menu, select **NORM/INVERT** for normal/inverted control of the PAN function
- **TILT INVERT** menu, select **NORM/INVERT** for normal/inverted control of the TILT function
- **OPTICS SPEED** menu, select **SLOW/FAST/RAPID** optics speed
- **BLACKOUT** menu, select **INSTANT** for immediate activation of PAN/TILT blackout when selected using the control channel or **DELAY** for 3 second delay before activation. **DIMMER** menu for selection of **DIM1/DIM2/DIM3/DIM4/OFF** special dimming curves
- **CURV** allows the user to adjust the shape of the dimming curve. See the CURV chart to understand more about actual dimming curves.
- **DIM INVERT** menu, select **NORMAL/INVERT** for normal/inverted control of DIMMING function

3.8 ACCESS

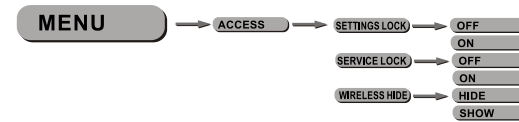

- Select **ACCESS** from the **SERVICE** menu
- **SETTINGS LOCK** menu, select **OFF/ON** to enable access to **SETTINGS** menu
- **SERVICE LOCK** menu, select **OFF/ON** to enable access to **SERVICE** menu
- **WIRELESS HIDE** menu, select **HIDE/SHOW** to show wireless options in settings menu

3.9 CONTENT



- Select **CONTENT** from the **SERVICE** menu
- **DISPLAY 1** menu, edit first line of display content
- **DISPLAY 2** menu, edit second line of display content
- **SEND** menu, select **YES** in order to transfer display content to all fixtures currently connected via data cable

3.10 SERVICE



- In order to reset custom modes to default values select **REST** .

3.66 CALIB.M

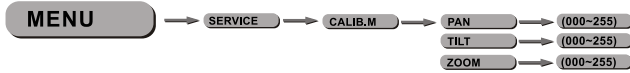

- Select **【CALIB.M】** from the **【SERVICE】** menu in order to calibrate the motors
- Adjust the values of the **【PAN/TILT/ZOOM】** motors in order to calibrate the start motor position

3.7 CALIB

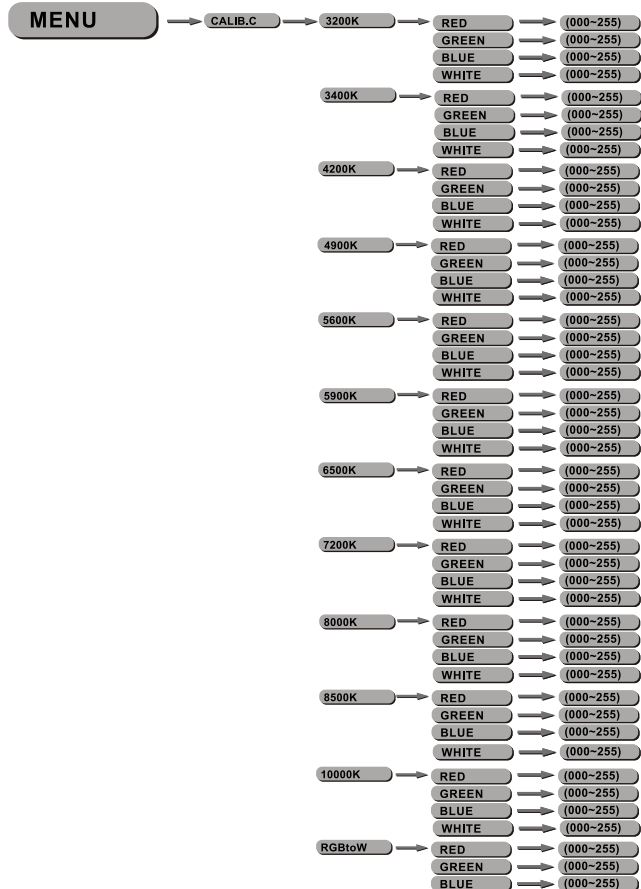

- Enter the **【Calib】** to select white color of different color temperature.
- There are 11 pre-programmed White colors plus RGB TO WHITE and can be edited by using **【Red】** , **【Green】** , **【Blue】** & **【White】** .

- **【COLOR】** is for activate/unactivate the color calibration functions. When **【RGBtoW】** is selected, on **RGB = 255,255,255**, the color is displayed as calibrated in **CAL2 -- RGBW**. When **【COLOR】** is set **【OFF】**, on **RGB = 255,255,255**, the RGB values are not adjusted and the output is most powerful. When **【UC】** is selected, the RGB output are adjusted to a standard preset universal color which balances fixtures from different generations.
- **【DMXerror】** menu, select **【SAVE】** to maintain last command in case of DMX error or **【BLACK】** for blackout
- **【DMXreset】** menu, select **【DMX】** to allow remote reset using DMX controller or **【DISPLAY】** for reset only available at on-fixture display
- **【DISPLAY ON】** menu, select **【LONG/SHORT/ALWAYS】** for length of time for display backlight
- **【HOME SCREEN】** menu, select **【DMX】** to display DMX address or **【NAME】** for product/manufacturer name
- **【Display Invert】** menu, select **【NORMAL/INVERT】** display direction
- **【Zoom pos】** menu, select **【NORMAL/INVERT】** display direction

3.53 INVERT

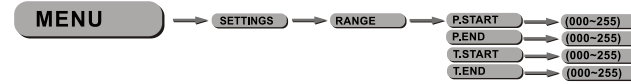

- Select **【P.start】** / **【P.end】** / **【T.start】** / **【T.end】** to which is from (001-512)

3.54 DISPLAY LOCK



- Choose the **【Display lock】** key lock Settings

3.55 DEFAULT



- This functions will reset all setting to the original factory setting

3.56 SEND



- Select **【SEND】** from the **【SETTINGS】** menu in order to send all settings to all fixtures currently linked via data cable

3.61 RUN

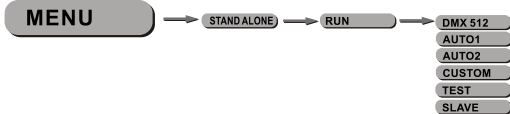

- Enter the **【STAND ALONE】** menu to select from **【AUTO 1/AUTO 2/CUSTOM/TEST/SLAVE】** run modes

3.62 EDIT

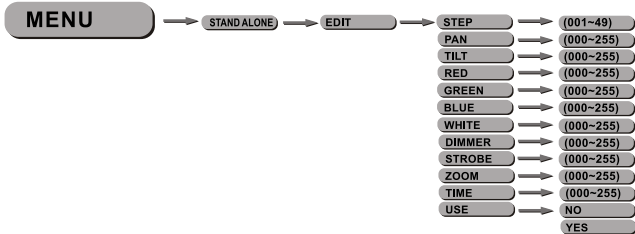

- Enter the **【Edit】** mode to edit the custom programs by adjusting the value of **【Step】**, **【Pan】**, **【Tilt】**, **【Red】**, **【Green】**, **【Blue】**, **【White】**, **【Dimmer】**, **【Strobe】**, **【Zoom】**, **【Time】**
- Enter **【Use】** and select **【Yes】** to run the steps user need.

Note: if user want to circulate the created steps, please set the last step 's **【Time】** as 0

For example, there are 3 steps, the setting should be like belowed:

- Step 1 **【Time】** = 4 **【Use】** = Yes
- Step 2 **【Time】** = 5 **【Use】** = Yes
- Step 3 **【Time】** = 0 **【Use】** = Yes

3.63 SEND



- Select **【SEND】** from the **【STAND ALONE】** menu to send the **【CUSTOM】** program to all fixtures currently linked via data cable

3.64 INFO

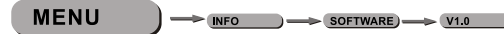

- Select **【INFO】** from the **【Stand alone】** menu in order to view the **【Software】** version UID number

3.65(1) MANUAL



- Select **【RESET】** from the **【MANUAL】** menu
- **【ALL RESET】** menu, select **【YES/NO】** to carry out full fixture reset
- **【PT RESET】** menu, select **【YES/NO】** to carry out PAN/TILT reset
- **【OPTIC RESET】** menu, select **【YES/NO】** to carry out OPTIC reset

3.65(2) MANUAL

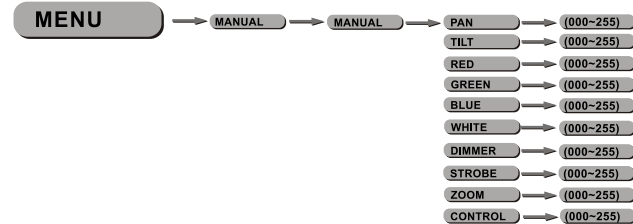

- Select **【MANUAL】** from the **【MANUAL】** menu
- Adjust the values of **【PAN/TILT/RED/GREEN/BLUE/WHITE/DIMMER/STROBE/ZOOM】** in order to carry out manual control